

Visagière

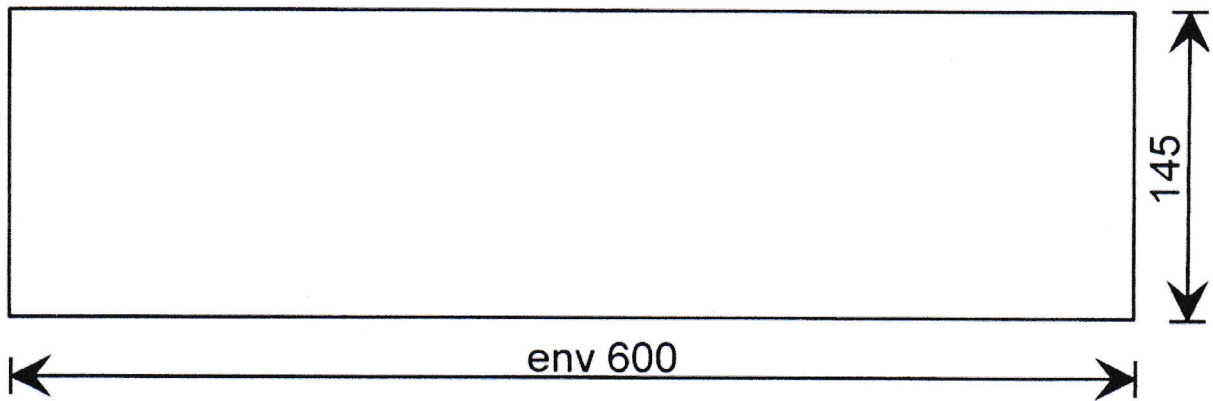

Fond

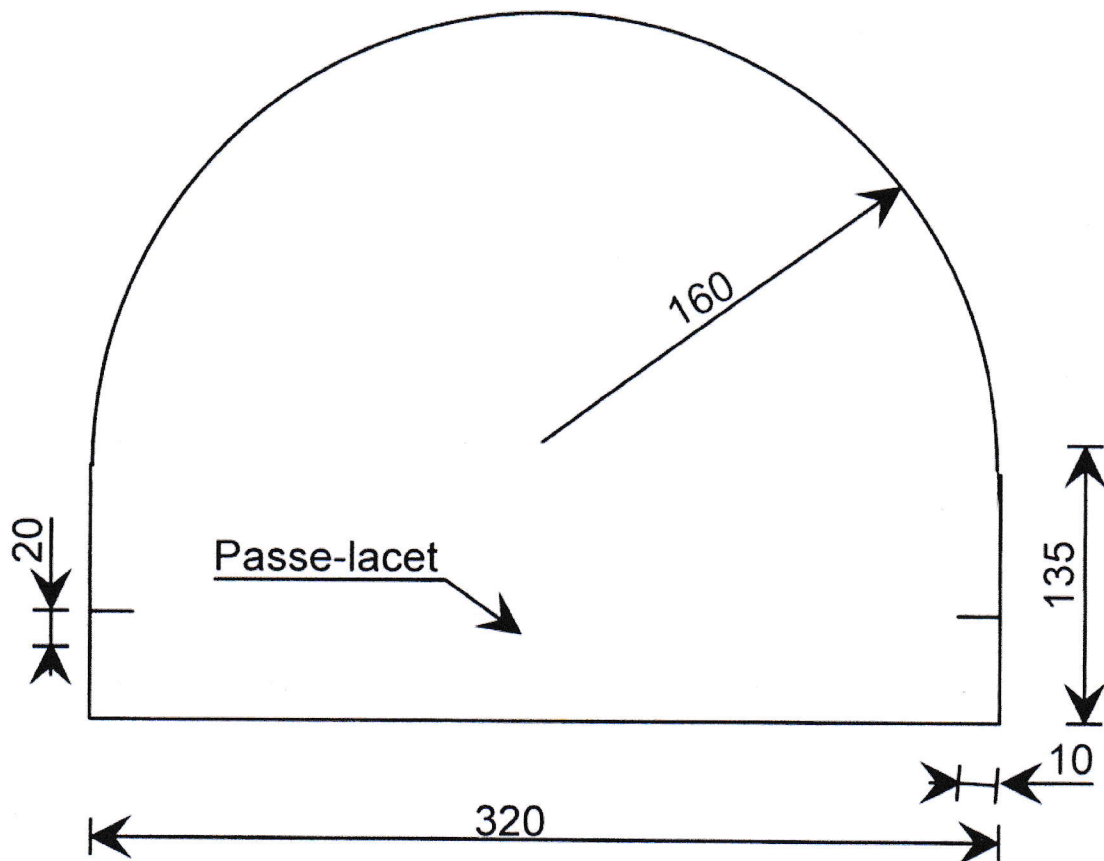

Mesures en mm

Copy-Right : J-Louis Guégaden pour KBC Penmarc'h

# "POCH DU" POUR COIFFE KERITIENNE

TAILLE 36/38

- PIECES A DECOUPER -

Page 1/4

Visagière

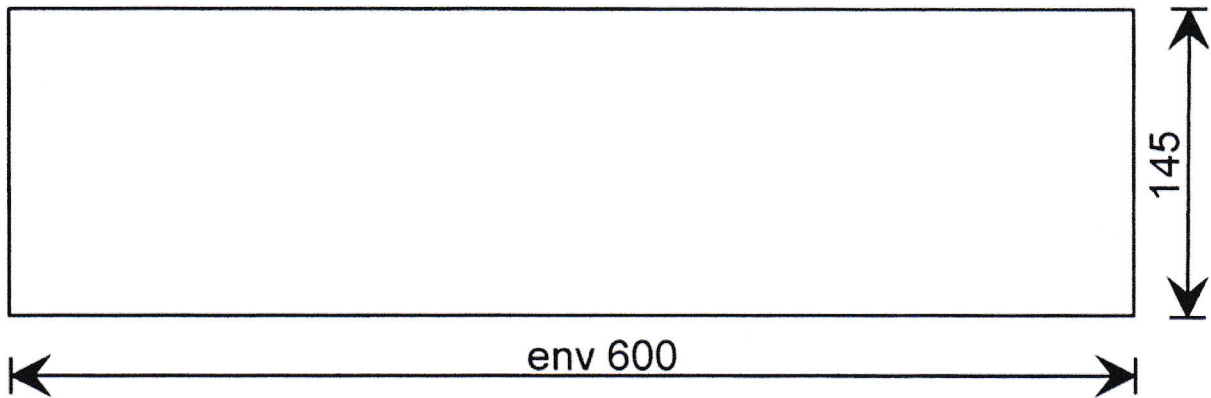

Fond

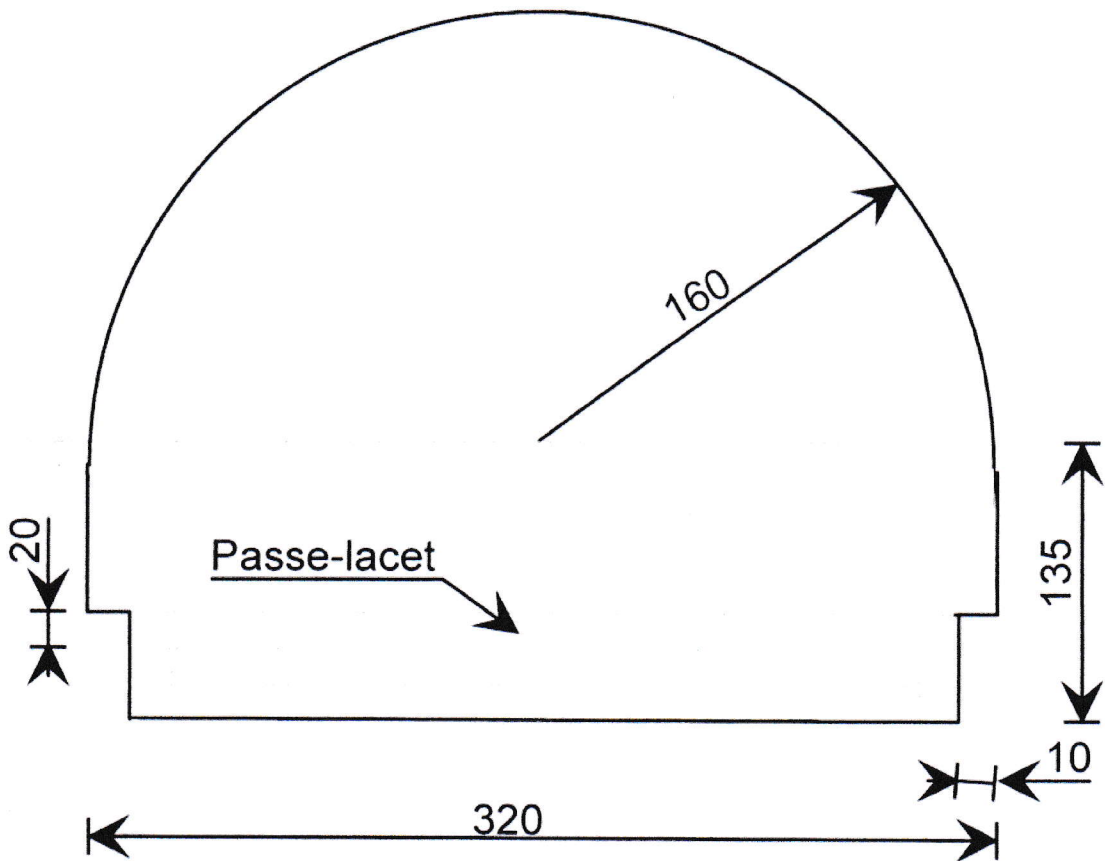

Mesures en mm

Copy-Right : J-Louis Guégaden pour KBC Penmarc'h

# "POCH DU" POUR COIFFE KERITIENNE

TAILLE 36/38

- PIECES A FABRIQUER -

Page 2/4

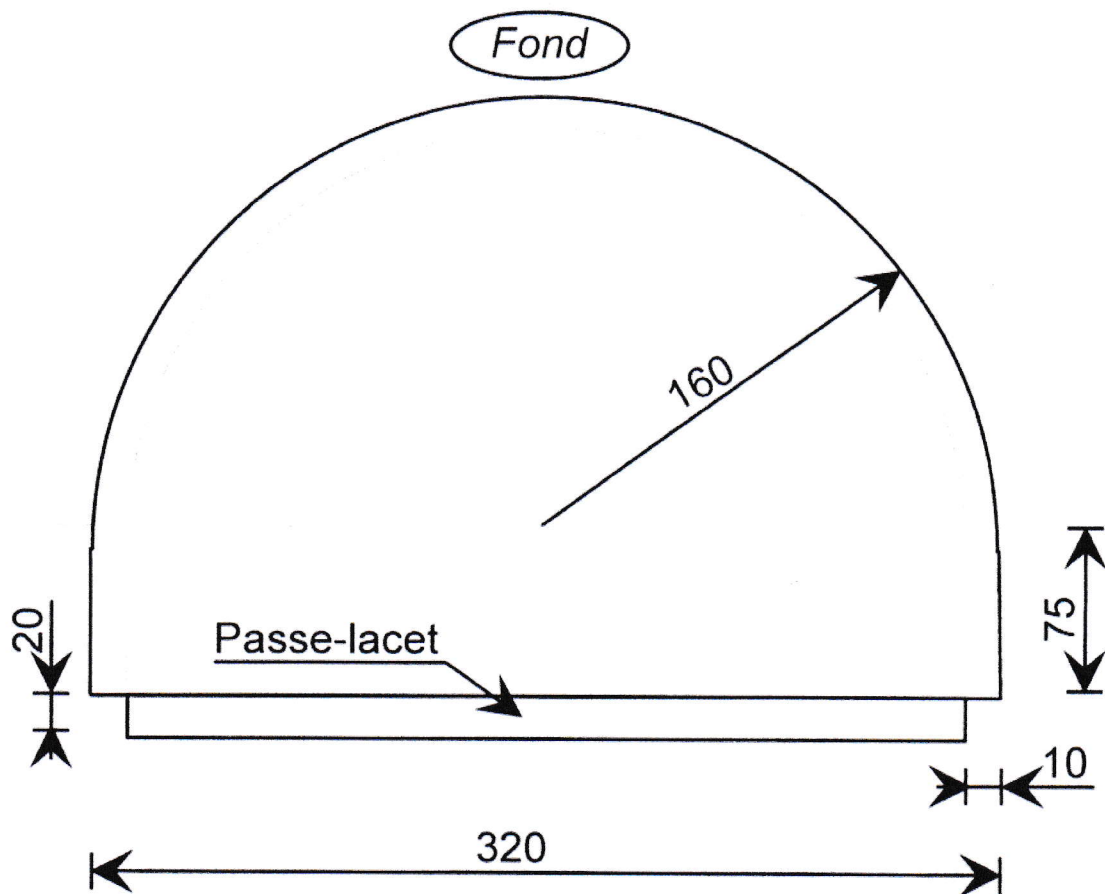
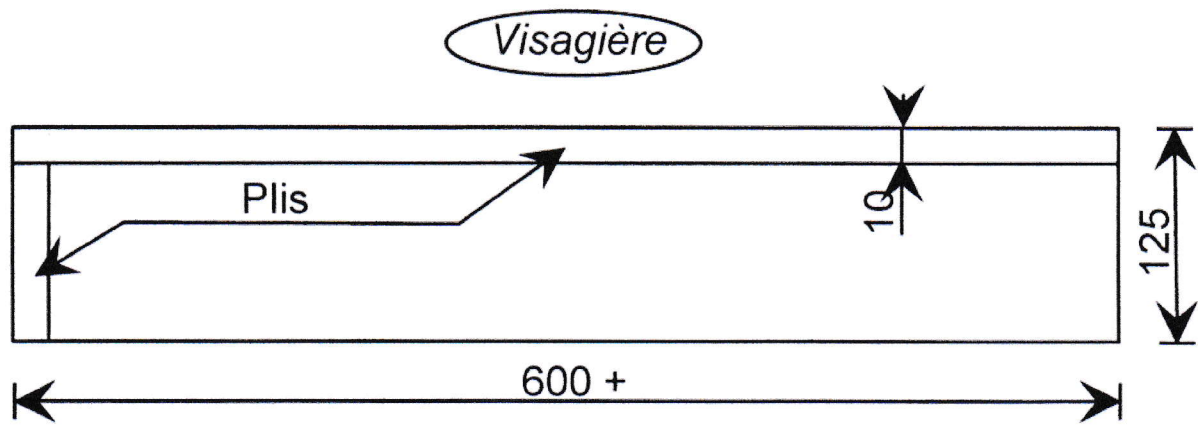

Mesures en mm

Copy-Right : J-Louis Guégaden pour KBC Penmarc'h

## "POCH DU" POUR COIFFE KERITIENNE

TAILLE 36/38

- PIECES A FABRIQUER -

Page 3/4

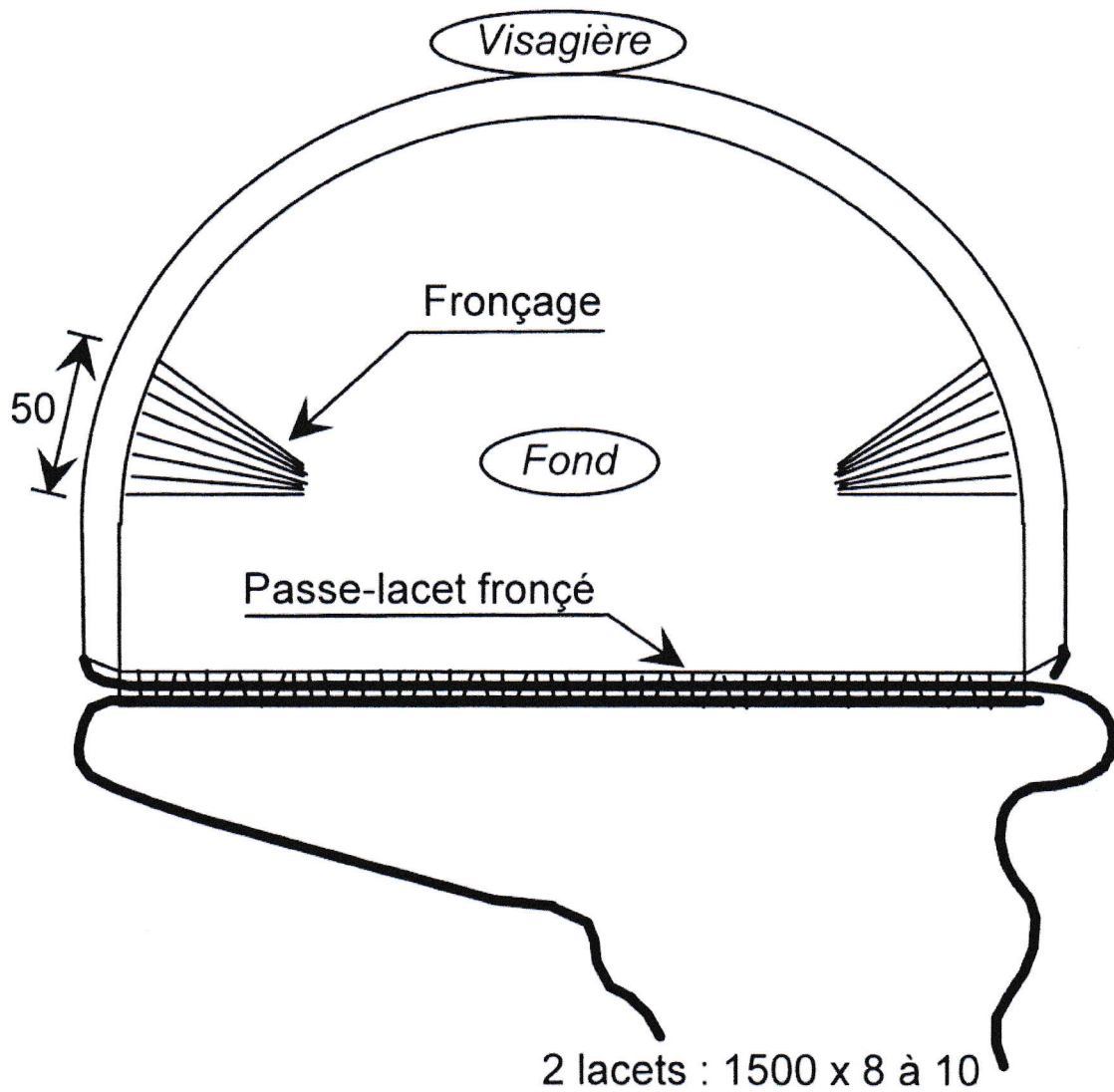

Mesures en mm

Copy-Right : J-Louis Guégaden pour KBC Penmarc'h

## "POCH DU" POUR COIFFE KERITIENNE

TAILLE 36/38

- MONTAGE -

Page 4/4